



CONTRACT SPECIALTY

BOTTOM UP ROLLER SHADE

AC Powered Motorized Control



The OpenLight Contract Bottom Up Shading System is an innovative system, perfect for ground floor or office applications where privacy and light harvesting are required. Bottom Up shades let the natural light in from the top of the window while shading the bottom section for privacy and solar control. Utilizing OpenLight Contract manual or motorized / automated systems combined with an innovative self-levelling hem bar adjusting system which limits service calls and ensures a long, trouble free life of the system.

FEATURES

- RTS Radio and Wired Mechanical Limit wired communication options to interface with popular motor controller options.
- Standard AC hardwired and AC transformer powering options available.
- Newly designed Heavy Duty Idler assembly consists of Teflon and glass filled nylon to eliminate noise and resist wear and tear for the life of the shading system.
- Powder coated steel box brackets 1/16" thick
- Wall mounted, desktop and stylish handheld controls available
- Optional integration with many popular automation systems.



CONTROL OPTIONS

myLink/ Smart Phone



Remote Controls



Sun Sensor



BRACKET COLOURS



white vanilla gray bronze black

FRONT & SIDE VIEW

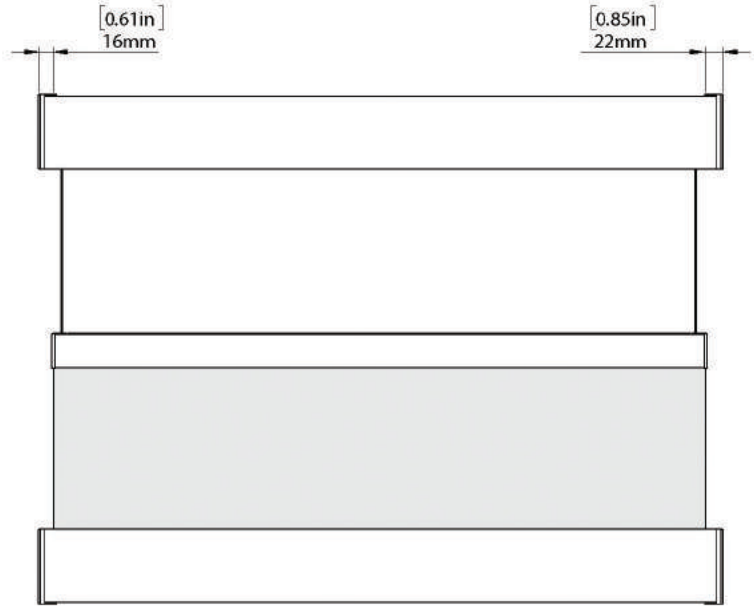
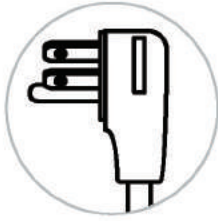
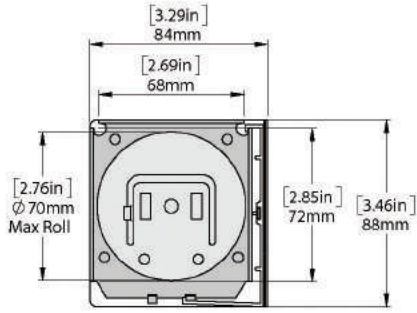

SCHEMATIC

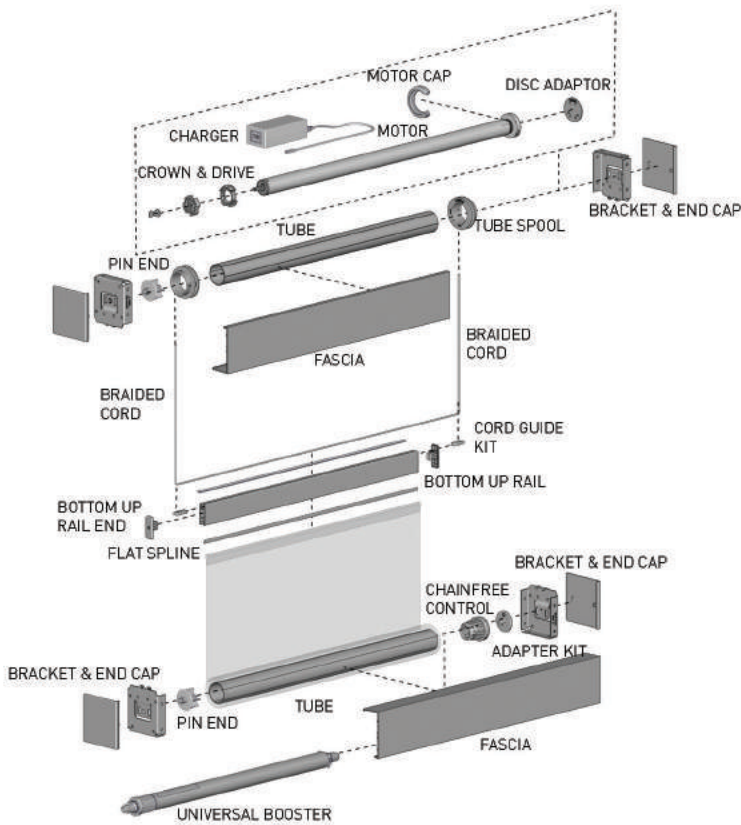

BOTTOM RAIL OPTIONS

Bottom Up Rail

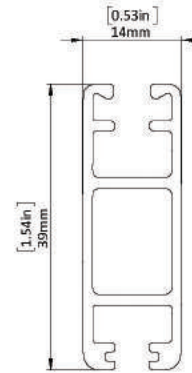

SYSTEM UPGRADES

5" Pocket

[for hidden recess mounts]



L & I Clips

[for hidden recess mounts]



Edge Side Channels

[for improved light blackout]



LOW VOC



NRC



LEED



HPD

Match this solution with any of our sunscreen, blackout or high performance fabrics for a complete finished solution. See our document library for comprehensive information including HPD, LEED & NRC specifications.



CONTRACT SPECIALTY BOTTOM UP ROLLER SHADE

Low Voltage 12V / Solar / Li-ion Battery

The OpenLight Contract Bottom Up Shading System is an innovative system, perfect for ground floor or office applications where privacy and light harvesting are required. Bottom Up shades let the natural light in from the top of the window while shading the bottom section for privacy and solar control. Utilizing OpenLight Contract manual or motorized / automated systems combined with an innovative self-levelling hem bar adjusting system which limits service calls and ensures a long, trouble free life of the system.

FEATURES

- Optional Solar Panel provides permanent net-zero, off grid charging option in a discrete and efficient package with multiple mounting options
- Internal Li-ion rechargeable battery will provide 500+ complete rotation cycles before recharging is required.
- Low voltage wired power panel and transformer options available to compliment most low voltage wiring scenarios.
- Newly designed Heavy Duty Idler assembly consists of Teflon and glass filled nylon to eliminate noise and resist wear and tear for the life of the shading system.
- Powder coated steel box brackets 1/16" thick
- Wall mounted, desktop and stylish handheld controls available
- Optional integration with many popular automation systems



BRACKET COLOURS



CONTROL OPTIONS

myLink/ Smart Phone



Solar panel



Remote Controls



Sun Sensor



FRONT & SIDE VIEW

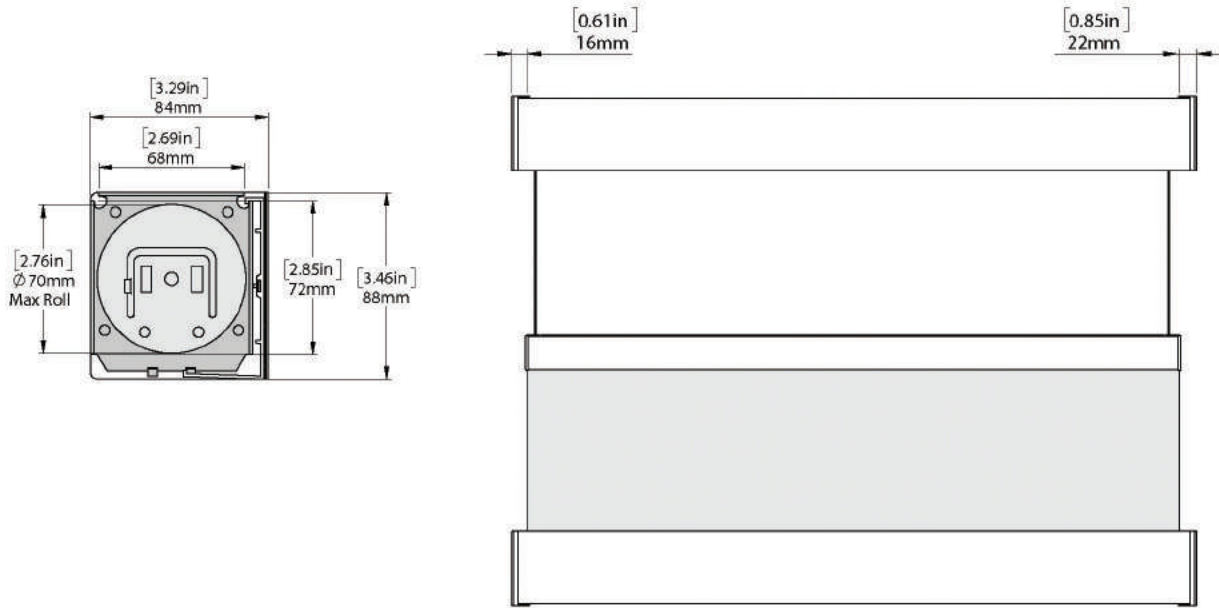

SCHEMATIC

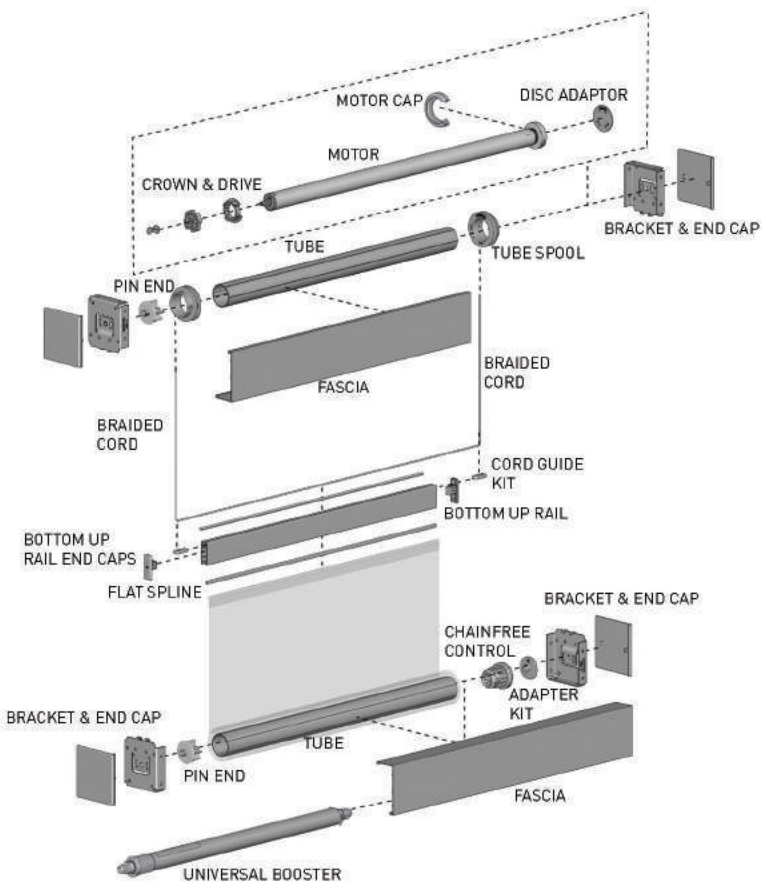

BOTTOM RAIL OPTIONS

Bottom Up Rail

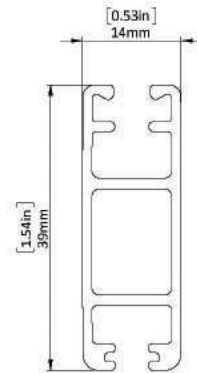

SYSTEM UPGRADES

5" Pocket

[for hidden recess mounts]



L & I Clips

[for hidden recess mounts]



Edge Side Channels

[for improved light blackout]



LOW VOC



NRC



LEED



HPD

Match this solution with any of our sunscreen, blackout or high performance fabrics for a complete finished solution. See our document library for comprehensive information including HPD, LEED & NRC specifications.